

**Where to find the Seat Connector Kit**

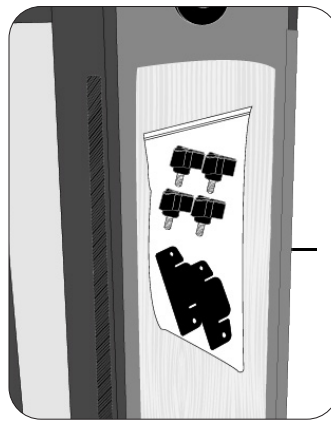
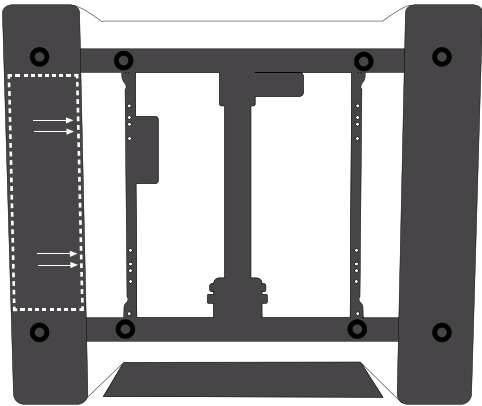

Scan this QR code for an instructional video.  
<https://vimeo.com/696205281>

Tip the seat over and locate the Velcro strip on the attached arm. Open it to expose the inside compartment of the arm. The Seat Connector Kit will be in a bag attached to the inside of the arm.

**Seat Connector Kit Contents**

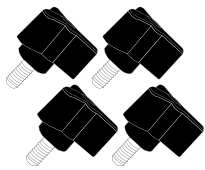

Qty (4) Wing Screws

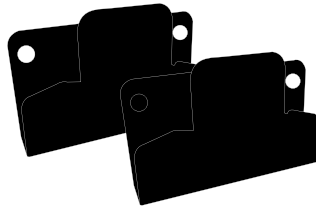

Qty (2) Right Arm Brackets

- or -

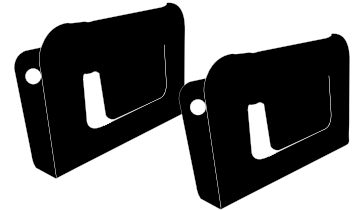

Qty (2) Left Arm Brackets

Open the fabric covering the arm and locate the threaded holes. There will be 2 on each side, for a total of 4.

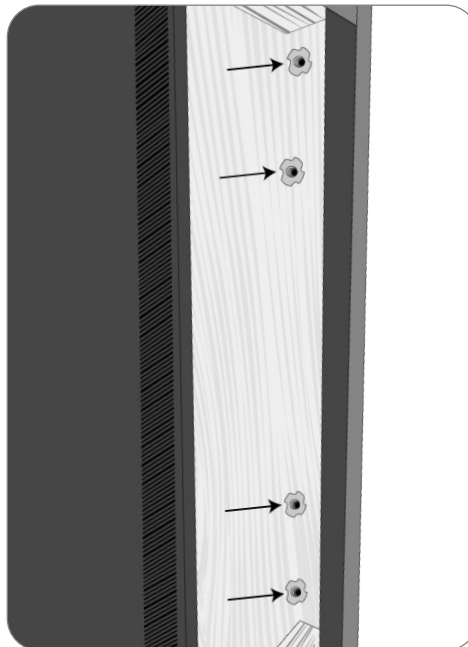
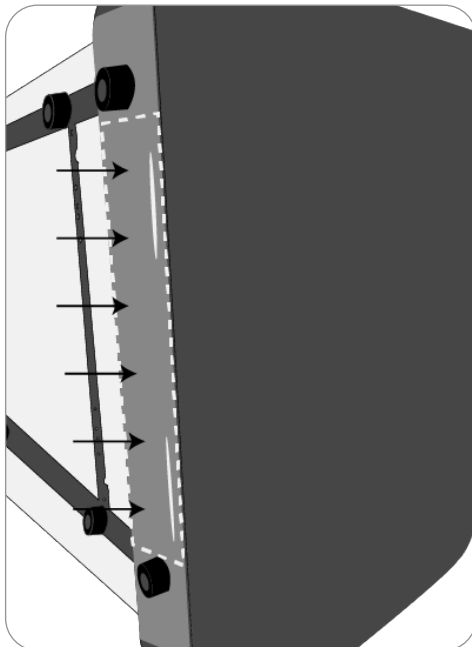

Slide each of the Brackets onto the arm and line it up with the threaded holes (there will be pre-cut slits in the cover for each bracket).

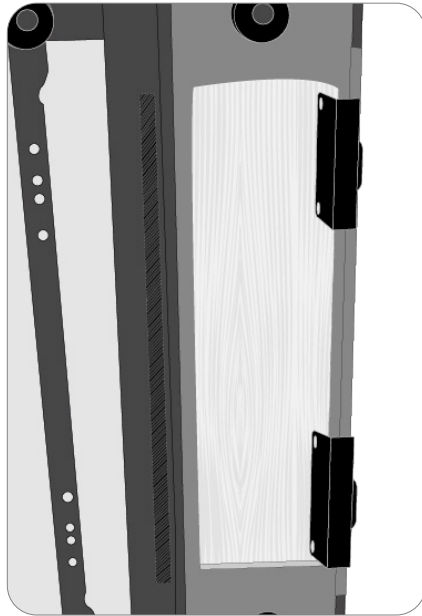
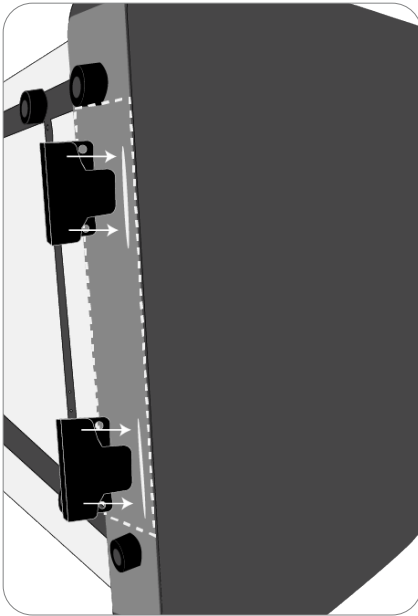

Screw the Wing Screws through the Brackets into the pre-drilled threaded holes. Tighten by hand, no tools required.

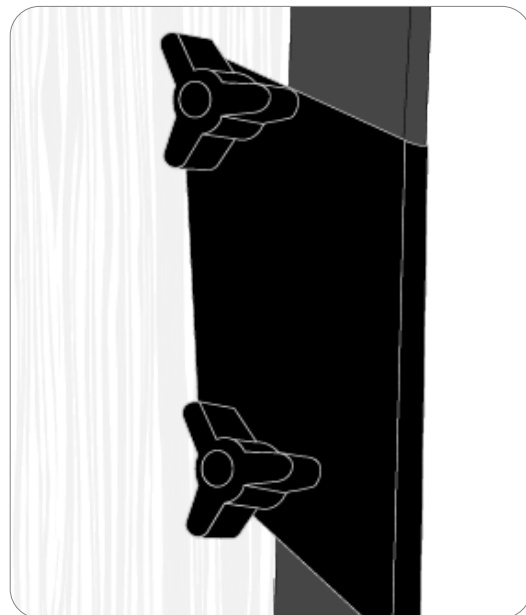
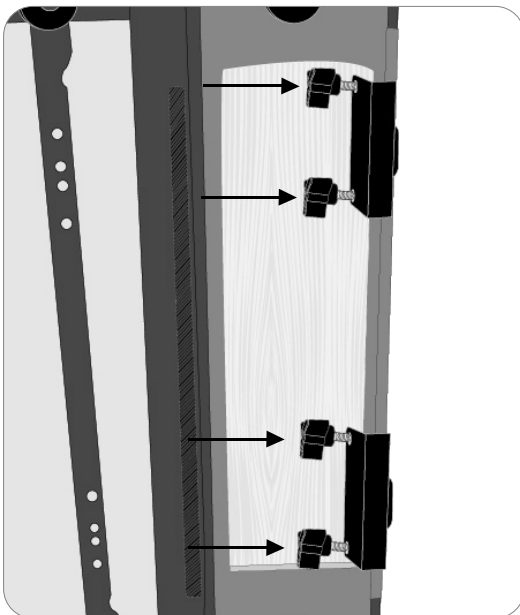

Once the Brackets are attached, close the fabric cover using the Velcro strip. Turn the seat back upright.

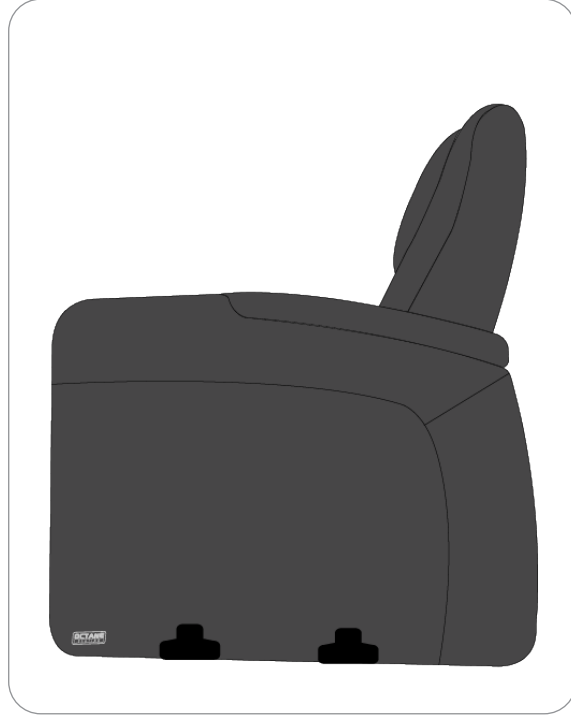
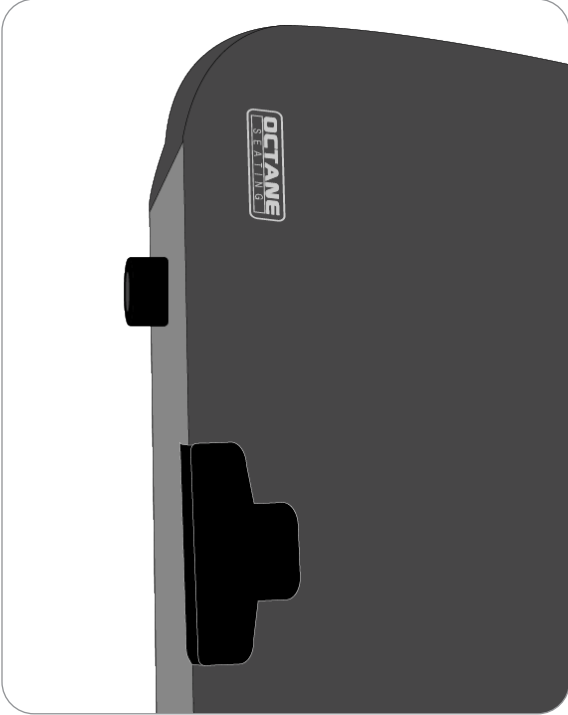

Attach the seat to the chair next to it by slightly lifting it up and positioning it into the bracket of the connecting seat.

